

TRACK OF
SURGICAL



Manufacturers & Exports of
Dental Implant Instruments

www.trackofsurgical.com



TRACK OF
S U R G I C A L

Track of Surgical is the specialist manufacturer of Dental instruments. Since 1964, for over 48 years track of surgical has been sharpening its awareness for change, anticipates New needs and constantly improving its spectrum that's why the track of Surgical is the acknowledge world leader. we are situated in the beautiful city of Sialkot

in the north of Pakistan, which is a gateway to the visitors paradise Kashmir. We are involved in the manufacturing of top quality gyne instruments and are exporting to our prestigious customers throughout the world since many years. we manufacture instruments in a highly quality control environment and use CNC machines under the supervision of highly qualified professionals.

we als have fully equipped quality research lab to control the quality of instruments At each and every step we are using top quality medical grade stainless steel to produces our high quality products. The Track of surgical are in daily use all over the world. Trusted by countless surgeons because of their high quality of workmanship and correct patterns for all disciplines of surgery. the knowledge and expertise are based of 38 years over many years and guarantee that high standards are reliably maintained

Track of surgical will meet your challenge with superior services, outstanding access to specialty products manufacturers and aggressive pricing. our company helps you to realize top value for your investments in specialty or instruments. we guarantee you, ill benefit from our level of quality and ease of operation. stringent products tests provide for flawless quality assurance. Track of surgical has had its own laboratory for many years. designed for monitoring product quality and products process itself. the required analysis examinations are carried out and recorded

here on account of these standard we received the certification or ISO 9001 : 2008 CE. cGMP. Note all the size of the instrument is according to catalogue of aesculap. Martin Sklar downs, miltex, etc

We can supply the instruments exactly according to the above catalogues. Quality assurance dose not just mean testing, as far as we concerned, but also the organization of the production Process with. the customers in mind. the costumers in strictly following the policy of not employing child labor in keeping with moral and international laws most importantly we know how important

Your job is and our goal is to help make you more effective efficient. A buyer empowered by knowledge is buyer we want to know. we eager to serve your esteemed and prestigious and excellent services, Which are also the hallmark of our organization. we ar manufacturing instruments as per specification and drawing provided by the buyers.



TRACK OF
SURGICAL





GRACEY CURETTE & SINUS LIFT



TRACK OF SURGICAL

Available Handle



Stainless Steel



Gold

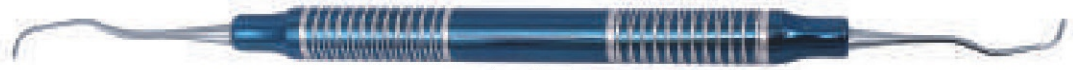

786 Fig 1/2 Gracey



787 Fig 3/4 Gracey



788 Fig 5/6 Gracey



789 Fig 7/8 Gracey



790 Fig 9/10 Gracey



791 Fig 11/12 Gracey



792 Fig 13/14 Gracey

Cassette

Sterilization Cassette is a safe way to handle instruments; it securely retains instruments in a perforated housing.



793



794



795



796



797

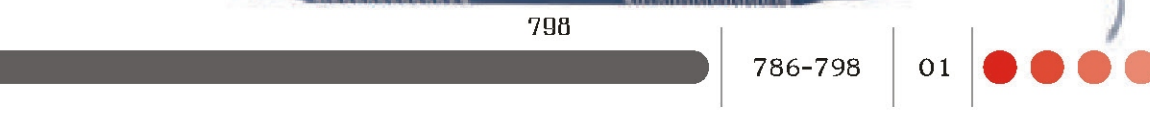

798



786-798

01





GRACEY CURETTE & SINUS LIFT

Available Handle



Stainless Steel



Gold



799 Fig 1/2 Gracey



800 Fig 3/4 Gracey



801 Fig 5/6 Gracey



802 Fig 7/8 Gracey



803 Fig 9/10 Gracey



804 Fig 11/12 Gracey



805 Fig 13/14 Gracey



Cassette

Sterilization Cassette is a safe way to handle instruments; it securely retains instruments in a perforated housing.



806



807



808



809



810

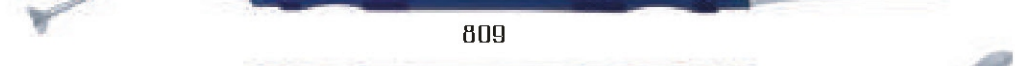

811



Available Handle







Stainless Steel

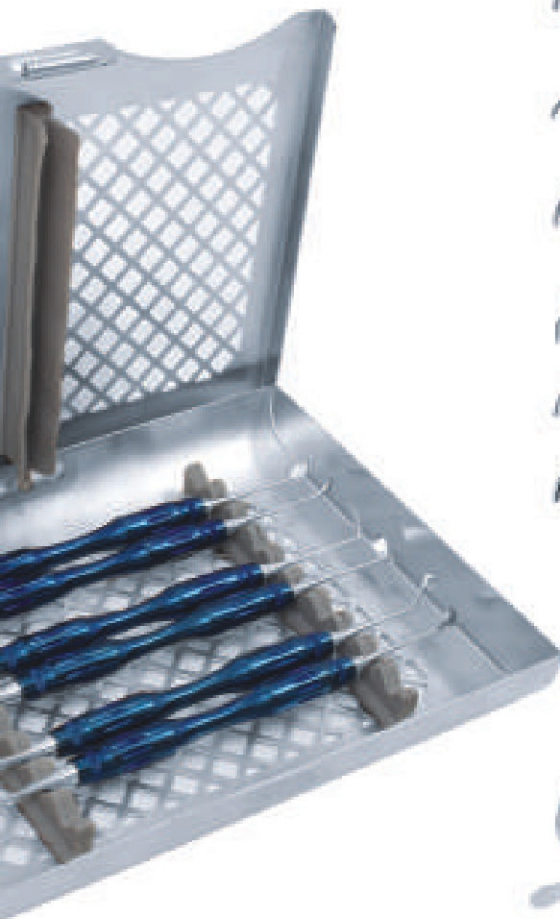



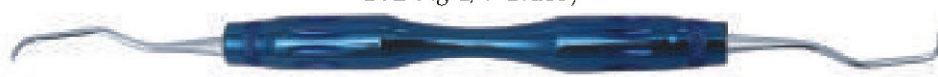

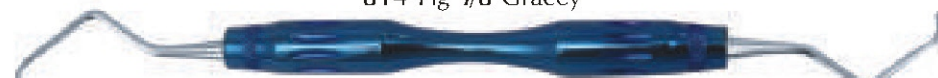
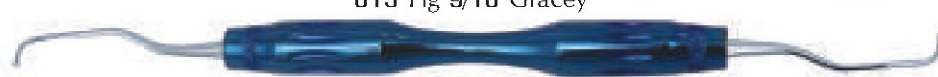
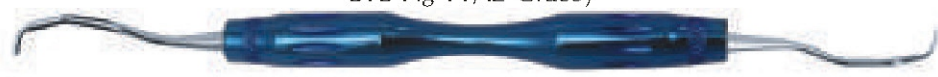
Gold



-  812 Fig 1/2 Gracey
-  813 Fig 3/4 Gracey
-  813 Fig 5/6 Gracey
-  814 Fig 7/8 Gracey
-  815 Fig 9/10 Gracey
-  816 Fig 11/12 Gracey
-  817 Fig 13/14 Gracey

Cassette

Sterilization Cassette is a safe way to handle instruments; it securely retains instruments in a perforated housing.

-  818
-  819
-  820
-  821
-  822
- 823



TRACK OF
SURGICAL



LUXATING SETS

Available Handle

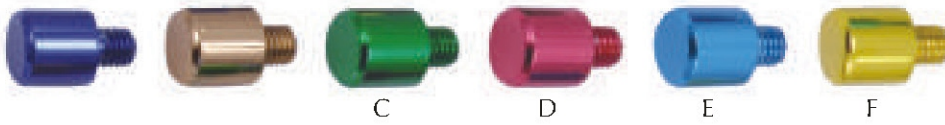

C

D

E

F



824



825



826



827



828



829



Cassette

Fine micro serrations to loosen the tooth from the socket and periodontal ligament. Surgical grade stainless steel coated with blue titanium for extra strength & durability during extraction



830



831



832



833



834



835



04

824-835





836 Fig 1/2 Gracey



837 Fig 3/4 Gracey



838 Fig 5/6 Gracey



839 Fig 7/8 Gracey



840 Fig 9/10 Gracey



841 Fig 11/12 Gracey



842 Fig 13/14 Gracey



843

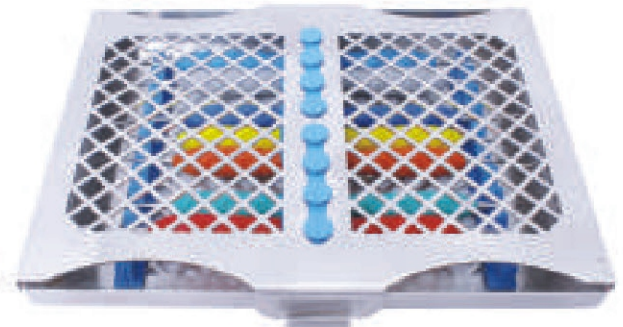



TORQUE & RATCHET WRENCH



844
Star Torque Wrench 6.35mm Universal



845
Round Torque Wrench 4.0mm Universal



846
Hex Driver With 4.0mm Driver



847
Star Torque Wrench 6.35mm Universal



848
Hex Torque Wrench 4.00mm Universal



849
Star Torque Wrench 6.35mm Universal



850
Star Torque Wrench 6.35mm Universal



851
Star Torque Wrench 6.35mm Universal



852
Star Torque Wrench 6.35mm Universal



853
Star Torque Wrench 6.35mm Universal



854
Star Ratchet Wrench 6.35mm Universal



855
Star Ratchet Wrench 6.35mm Universal



856
Star Ratchet Wrench 6.35mm Universal



857
Star Ratchet Wrench 4.0mm Universal



858
Round Ratchet Wrench 4.0mm Universal



859
Round Ratchet Wrench 3.35mm Universal



860
Star Ratchet Wrench 4.0mm Universal



861
Star Ratchet Wrench 6.35mm Universal



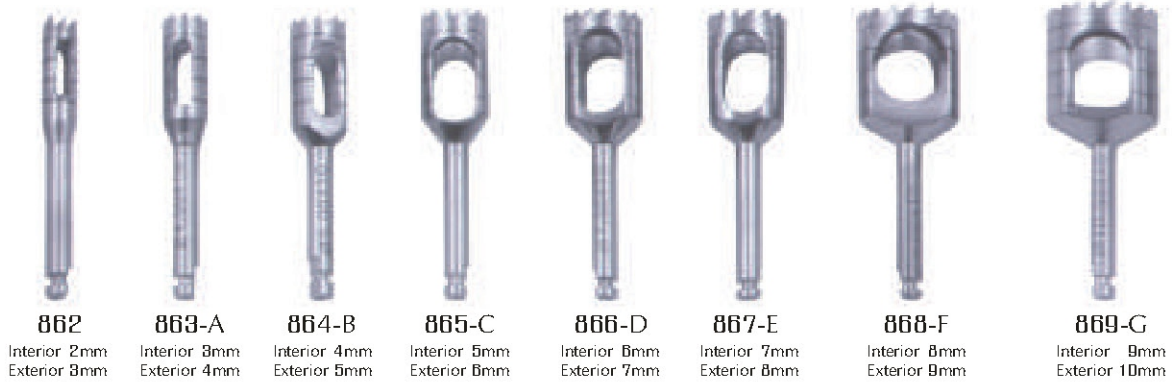

870
Trephine Drill & Drill Stand



Close View



871
Trephine Drill & Drill Stand

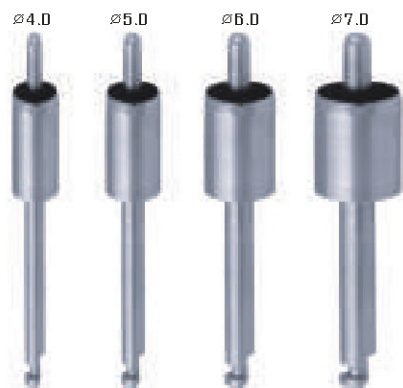

872
Tissue Punch With Pin



873
Short Implant Drills



874
Long Implant Drills

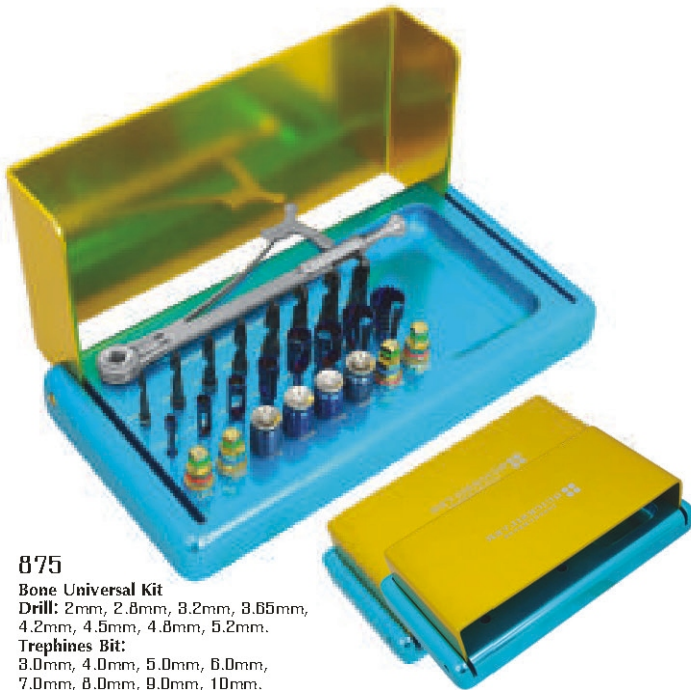

875

Bone Universal Kit
Drill: 2mm, 2.6mm, 3.2mm, 3.65mm, 4.2mm, 4.5mm, 4.8mm, 5.2mm.
Trephines Bit: 3.0mm, 4.0mm, 5.0mm, 6.0mm, 7.0mm, 8.0mm, 9.0mm, 10mm.
Driver:
 2.5mm, 2.5mm Hand Pcs
 1.25mm, 1.25mm Hand Pcs
 Short Driver 2.5mm
 Long Driver 2.5mm
 1.25mm, Short Hex Driver Hand Pcs
 1.25mm, Long Hex Driver Hand Pcs
 Torque Wrench 4.0mm



876

Bone Expander Kit
Expander: 2.6mm, 3.0mm, 3.4mm, 3.8mm, 4.3mm
 Ratchet Driver
 Parallel Pin
 Pilot Drill
 Drill 1.4mm
 Drill Driver 4mm
 Hand Driver 4mm
 Ratchet 4mm



877

Bone Universal Kit
Drill: 2mm, 2.6mm, 3.2mm, 3.65mm, 4.2mm, 4.5mm, 4.8mm, 5.2mm
Trephines Bit
 3.0mm, 4.0mm, 5.0mm, 6.0mm, 7.0mm, 8.0mm, 9.0mm, 10mm.

Bone Compression;
 2mm, 3.3mm, 2.8mm, 4.2mm, 3mm, 3.5mm
Driver:
 2.5mm, 2.5mm Hand Pcs
 1.25mm, 1.25mm Hand Pcs
 Short Driver 2.5mm
 Long Driver 2.5mm
 1.25mm, Short Hex Driver Hand Pcs
 1.25mm, Long Hex Driver Hand Pcs
 Torque Wrench 6.35mm 1 Pcs



878

Conical Drills: 20 Pcs
Tissue Punches:
 3.0mm, 3.50mm, 4.0mm, 4.5mm, 5.0mm, 6.0mm, 6.50mm
Bone Expander:
 1.6/2.6mm, 1.9/3.0mm, 2.1/3.6mm, 2.6/3.8mm, 2.9/4.3mm
Drill Adapter: 1 pcs
 1.25mm, 2.50 mm Hex Driver Hand Pcs
Pilot Drill: 1.6mm
Drill Bit: 1.4mm, 1.6mm, 1.8mm, 2.0mm, 2.2mm
Ratchet Driver: 4mm/6.35, 1.25/2.50
Rimer: 3.2/4.7mm, 3.7/4.7mm
Parallel Pin: 4.5mm, 2.5mm
Double Step Drill: 2.4/2.8mm
Depth Gauge: 1 Pcs
Torque Wrench 6.35mm Universal: 1 Pcs



OSTEOTOMES & SINUS LIFT ELEVATORS

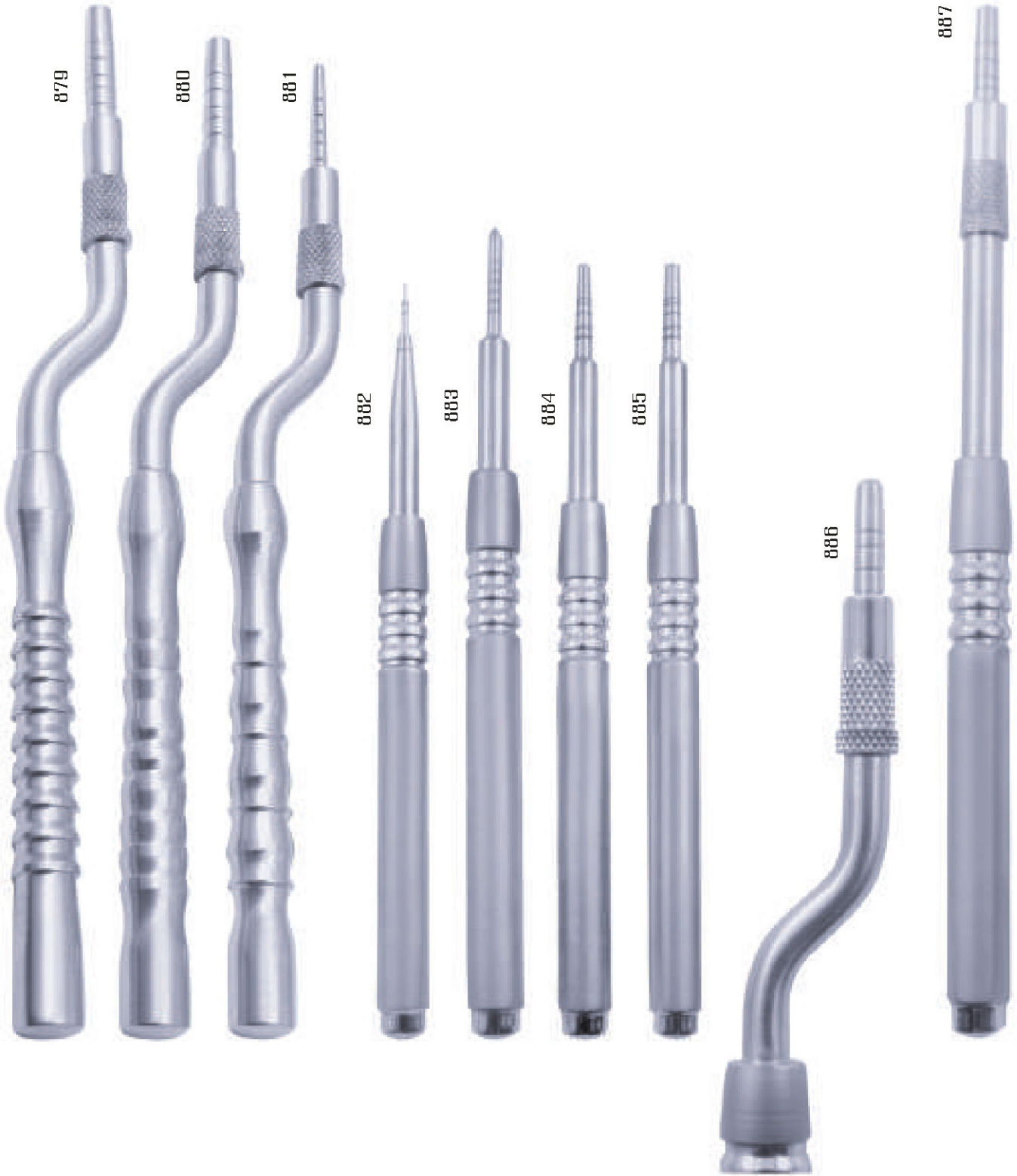

879-887

09





TRACK OF
SURGICAL

CROWN REMOVER & REUSABLE BONE SCRAPER

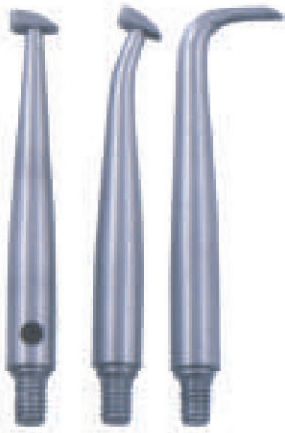

888

CROWN REMOVER



889



890

REUSABLE BONE SCRAPER

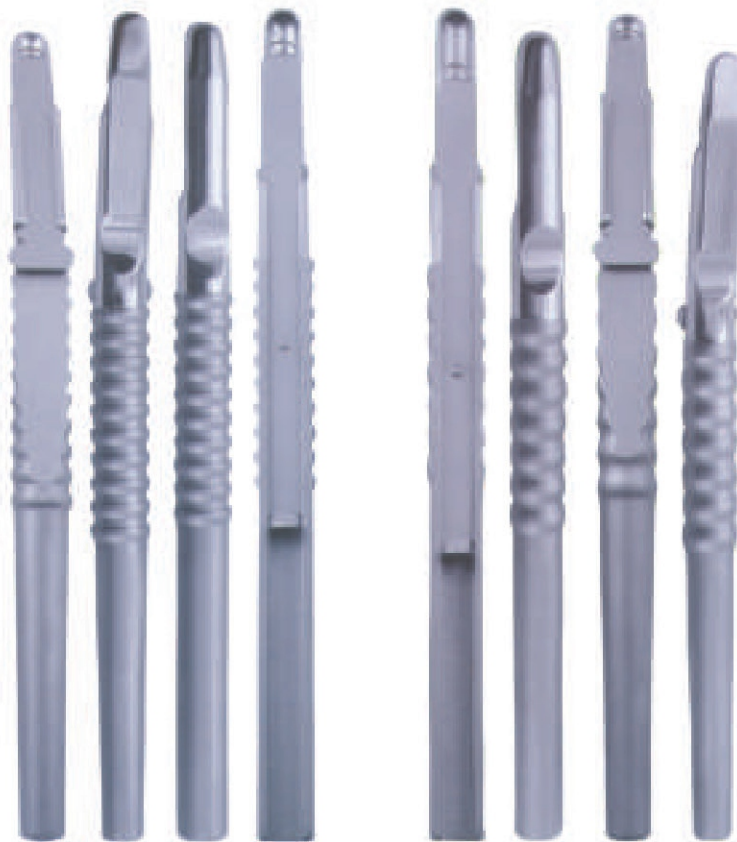

891

892



893



SINUS LIFT ELEVATORS





BONE CHISEL & SPREADERS



900



901



902



903

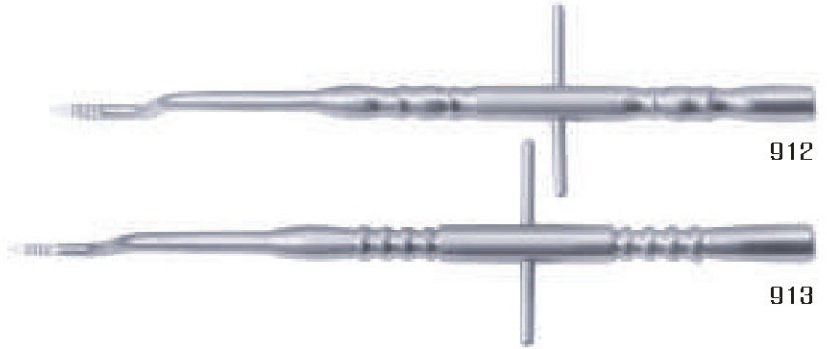

912

913

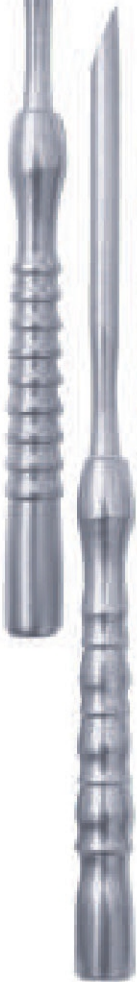

904



905



906



907

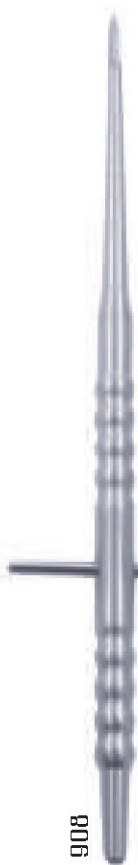

908

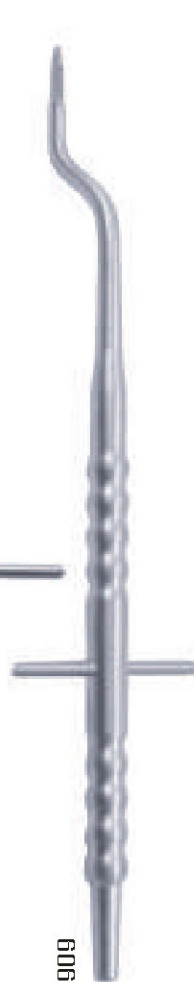

909



910



911



● ● ● ● ————
 OSTEOTOMES KIT



914

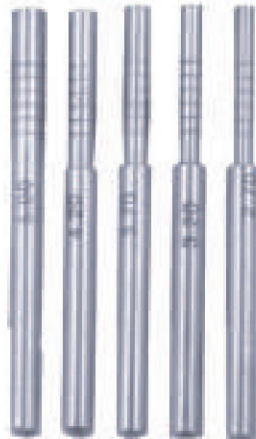

915

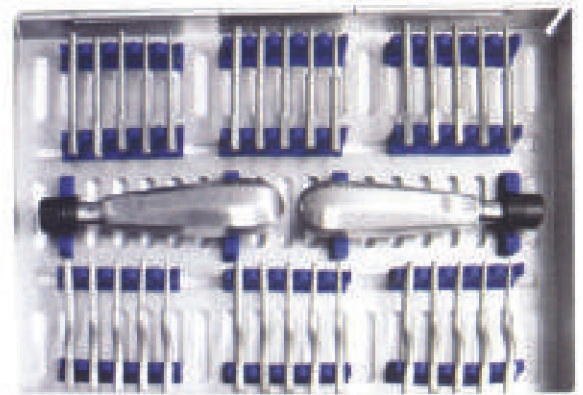

920



916

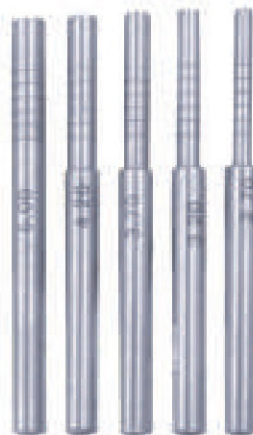

917



918



919



921



BONE WELL, BONE CRUSHER, BONE MILL



922

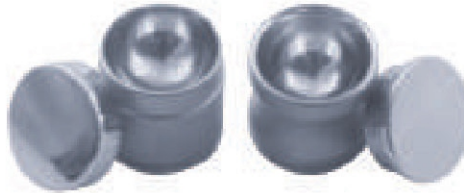

923



924



925



928



926



927





929



930



931



932



933



STANDARD SET OF FORCEPS SYSTEM



934
Standard Set Of Forceps System Stand



935
Right



936
Left



937
Easy Access To Molars
Right

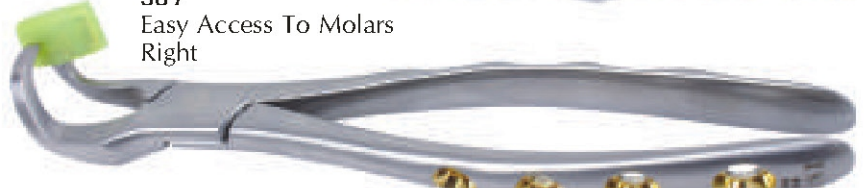

938
Easy Access To Molars
Left



939
Upper Right



940
Upper Left



941
Upper Anterior



942
Lower Universal





943



944



945



946



947



948



949



ENGLISH PATTERN



01-001
Fig. 1
For Upper Incisors
and Canines, Wide

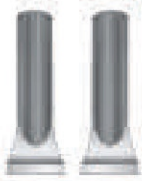

01-002
Fig. 106
For Upper Canines



01-003
Fig. 138
For Upper Premolars



01-004
Fig. 17
For Upper Molars, Right



01-005
Fig. 18
For Upper Molars, Left



01-006
Fig. 7
For Upper Premolars

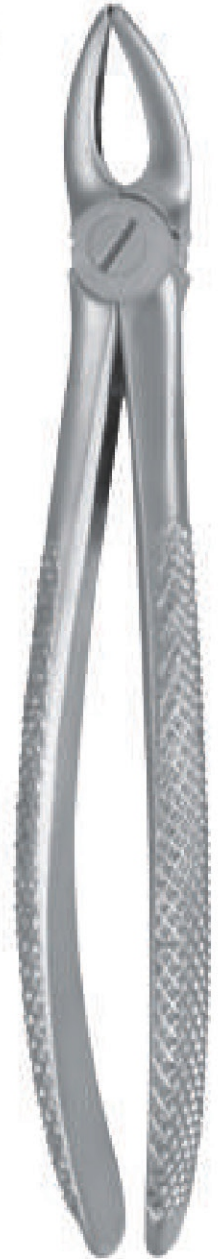

01-007
Fig. 87
For Upper Wisdom Teeth, Narrow
Available: For Upper Wisdom Teeth, Wide



01-008
Fig. 29
For Upper Front Roots

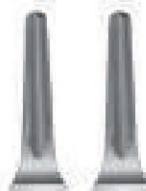

01-009
Fig. 30
For Upper Roots





EXTRACTION FORCEPS

ENGLISH PATTERN



01-010
Fig. 89
For Upper Molars,
Right, Gripping In Depth



01-011
Fig. 18 A
For Upper Molars, Either Side



01-012
Fig. 51 A
For Upper Front Roots,
Narrow Beaks



01-013
Fig. 18
For Lower Canines And Premolars



01-014
Fig. 88 A
For Lower Roots, With
Narrow Beaks



01-015
Fig. 88
For Lower Incisors,
Premolars And Roots



01-016
Fig. 75
For Lower Canines
And Premolars



01-017
Fig. 24
For Lower Molars, Left



01-018
Fig. 31
For Lower Premolars
And Roots



01-019
Fig. 78
For Lower Molars



01-020
Fig. 21
For Lower Wisdom
Teeth And Molars





ENGLISH PATTERN FOR CHILDREN



01-021
Fig. 37
For Upper Incisors

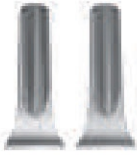

01-022
Fig. 158
For Upper Molars,
Either Side, Small



01-023
Klein
For Upper Incisors

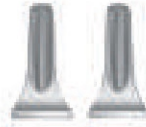

01-024
Schmidt
For Upper Roots

Also Available Upper
And Lower Molars

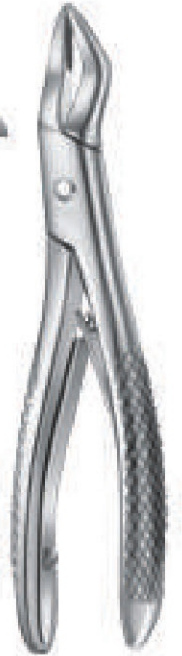

01-025
Klein
For Lower Incisors

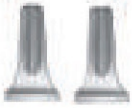

01-026
Klein
For Lower Roots



01-027
Cryer Fig. 150 S
Tooth Forceps For Children
For Upper Incisors, Canines
And Premolars



01-028
Cryer Fig. 151 S
Tooth Forceps For Children
For Lower Incisors, Canines
And Premolars And Molars

AMERICAN AND UNIVERSAL PATTERN



01-029
Harris Fig. 18 R
For Upper Molars, Right



01-030
Fig. 208
For Lower Incisors,
Premolars And Roots



01-031
Fig. 17
For Lower Molars



01-032
Fig. 222
For Lower Wisdom Teeth



01-033
Hull Fig. 101
Universal Tooth
Forceps

01-034
Cryer Fig. 151
For Lower Incisors, Canines,
Premolars And Roots





950



951



952



953



954



955



957



956



ORTHODONTIC PLIERS



Screw Lock
Box = S/L

Box Lock = B/L

Allen Wrench
Box = AW/L

All Pliers & Cutters Could Be Provided
In Adjustable Lap Joint Fitting,
Box Joint Fitting & Lap Joint Fitting.

All Pliers and Cutters are available
with Tungsten Carbide Tips.



958
Orthodontic Plier Stand
This Is A Matt Finish Metal
Orthodontic Plier Stand.
This Plier Stand Is Durable
And Strong. This Orthodontic
Plier Stand Is Orthodontist
First Choice.

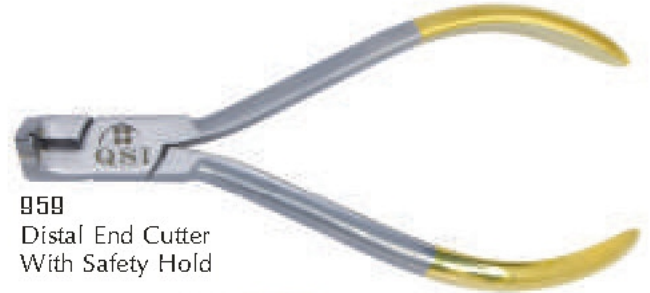

959
Distal End Cutter
With Safety Hold



1060
Three Jaw
Plier, Anderer



961
Bird Beak
Plier



962
Posterior Band
Removing Plier

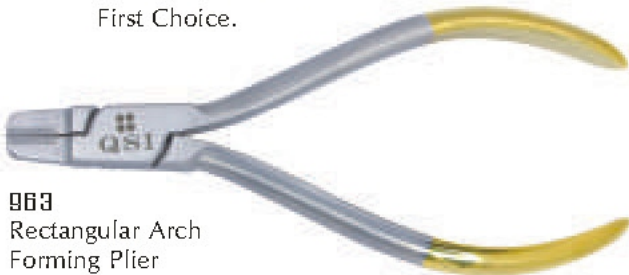

963
Rectangular Arch
Forming Plier



964
Pin & Ligature
Cutter, Straight



965
Standard How
Utility Plier



966
Utility Plier, Weingart



TRACK OF
SURGICAL



DENTAL SYRINGES



967 (1.8ML)
968 (2.2ML)
Angled



969 (1.8ML)
970 (2.2ML)
Angled



971 (1.8ML)
972 (2.2ML)
Angled



973 (1.8ML)
974 (2.2ML)
Angled



975 (1.8ML)
976 (2.2ML)
Angled



977 (1.8ML)
978 (2.2ML)
Angled



979 (1.8ML)
980 (2.2ML)
Angled



23

967-980



● ● ● ● ●
DENTAL SYRINGES



981 (1.8ML)
982 (2.2ML)

990 (1.8ML)
991 (2.2ML)



983 (1.8ML)
984 (2.2ML)

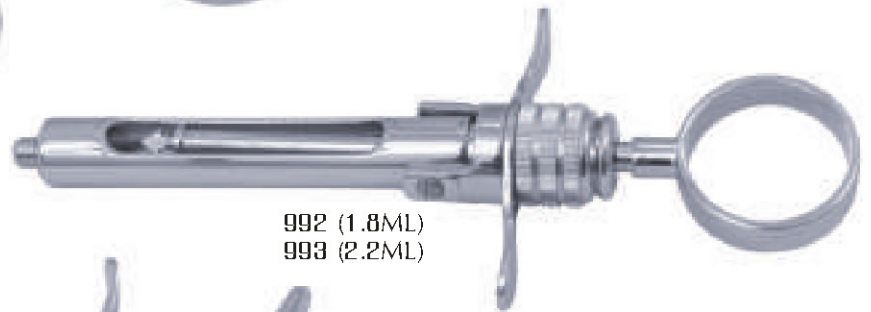

992 (1.8ML)
993 (2.2ML)

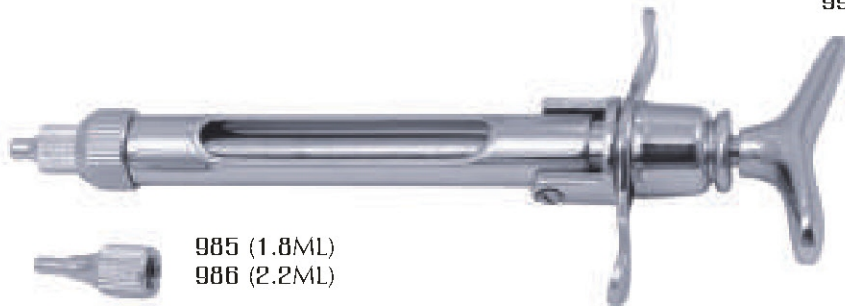

985 (1.8ML)
986 (2.2ML)



994 (1.8ML)
995 (2.2ML)



987 (1.8ML)
988 (2.2ML)
Angled





TISSUE PUNCHES, HAMMER & CALIPERS



996

997

998



999

1000



1001

1002



1003

Boley Decimal Gauge



1004

Castroviejo Caliper



1005

Iwanson Spring Caliper for Metal / Wax



1006

Bone Caliper - Ridge Mapping



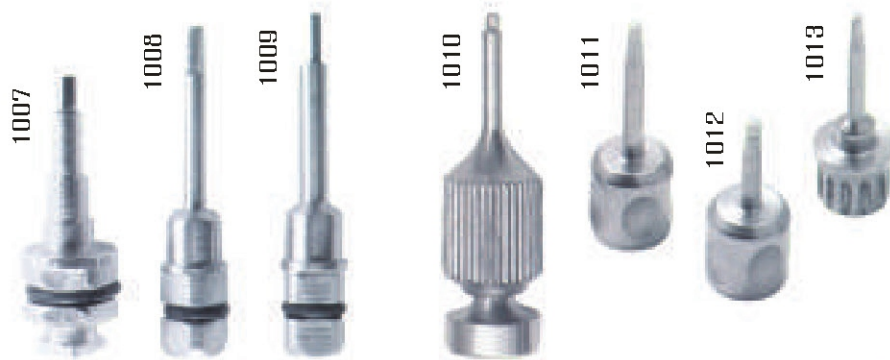

1014

1015

1016



1017

1018

1019



1008



1009

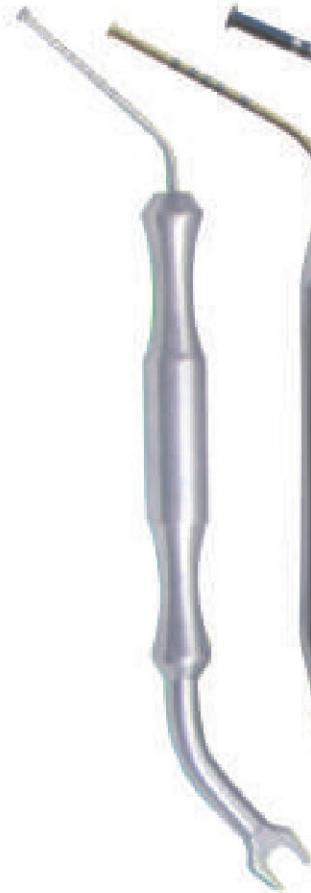

1010



1011



1012



1013



1014



1015





INSTRUMENTS CASSETTES & STANDS



1016
Instruments Cassettes
5 Pieces, 7 Pieces, 10 Pieces & 20 Pieces

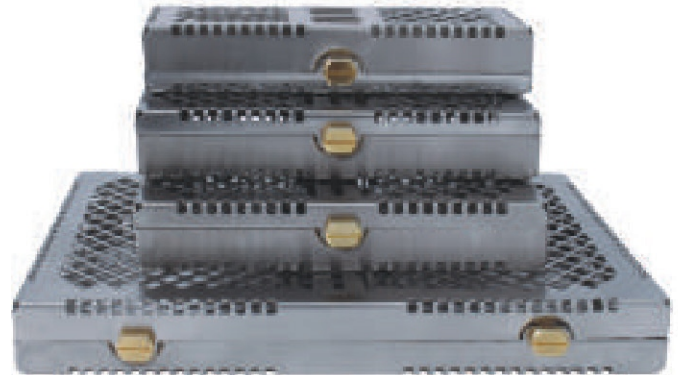

1017
Instruments Cassettes
5 Pieces, 7 Pieces, 10 Pieces & 20 Pieces

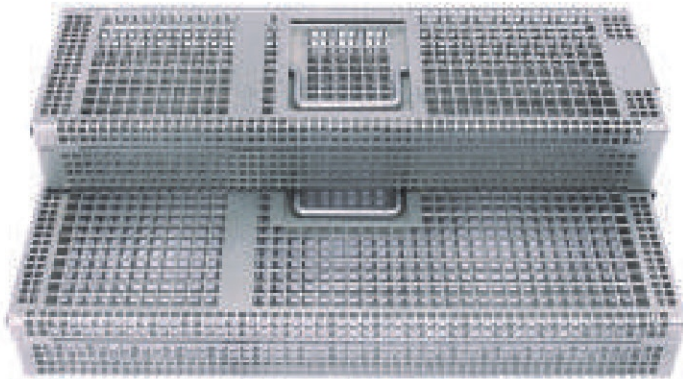

1018
Instruments Cassette
7 Pieces & 10 Pieces

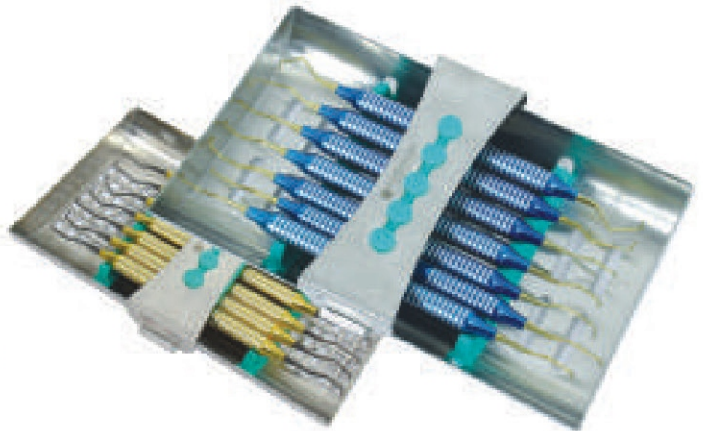

1019
Gracey Curette Set Cassettes

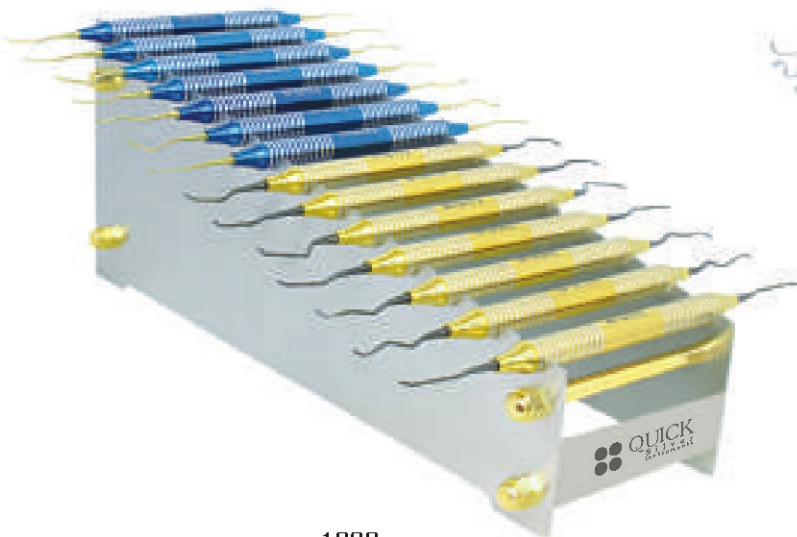

1020
Gracey Curette Set Stand

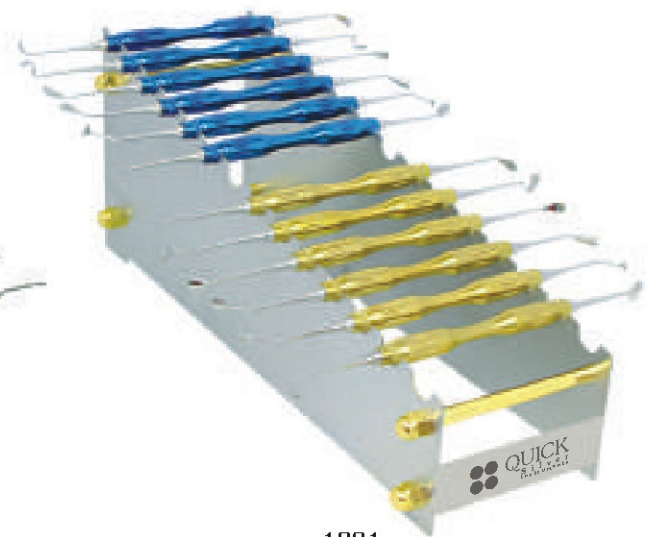

1021
Sinus Lift Set Stand





INSTRUMENTS CASSETTES

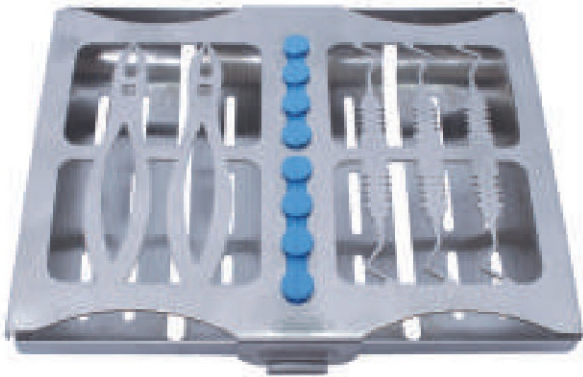

1022
Instruments Cassettes
10 Pieces



1023
Instruments Cassettes
20 Pieces

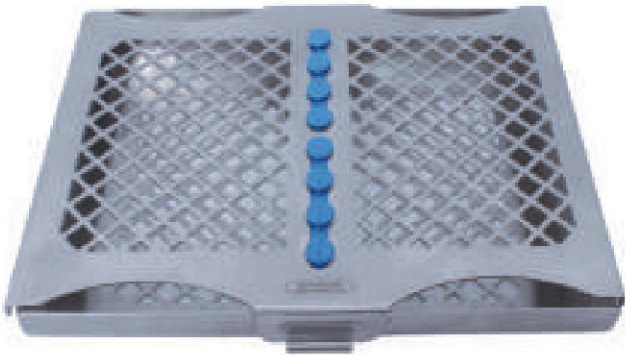

1024
Instruments Cassettes
20 Pieces



1025
Instruments Cassettes
5 Pieces



1026
Sterilization Basket & Tray
Size: 11" Width X 22" Length
Depth: 2", 3", 4", 5", 6"



1027
Sterilization Basket & Tray
Size: 11" Width X 16" Length
Depth: 2", 3", 4", 5", 6"



1028
Sterilization Basket & Tray





Commissiонер Road Sialkot -51310 - Pakistan

Phone : +92 52 4590 107

Phone : +92 52 4601 978

Fax : +92 52 4588 270

Email : info@trackofsurgical.com

Web: www.trackofsurgical.com